



CAPTOS MIFARE



CAPTOS iCharge MIFARE

CAPTOS MIFARE / CAPTOS iCharge MIFARE

Operating Instructions

Content

Page

General Description / Supplementary documents / Technical Specifications	2
Safety Precautions	3
Care & Maintenance / Factory Settings / Functional Description / Overview of transponder cards /	4
Additional functions with the Captos iCharge.....	5
Power Supply / Components of the locking system & package content.....	6
Dimensions.....	7
General assembly instructions / Mounting on non-metal surfaces	9
Cable management recommendations	12
Configuration and operation	14
Instructions for operation and configuration	15
Commissioning / Using the installation card / Programming the Master card	16
Programming the User Cards / Closing and opening	17
Unauthorised Transponders / Facility Manager Function / Emergency opening	18
Deleting Individual Transponder Cards	19
Deleting All Transponder Cards / Changing the operating mode.....	20
Deactivating and activating acoustic signals	21
Resetting to factory settings / Activation and deactivation of auto locking.....	22
Deactivating and activating the Status-LED.....	23
Activation and deactivation of unlimited shared use / Disposal	24

GENERAL DESCRIPTION

The Captos and Captos iCharge locking systems are electronic furniture locks based on RFID technology that are intended for use inside buildings. Power is supplied via cabling from a controller. The lock is available in the versions Captos and Captos iCharge. Captos iCharge has the same functions as the Captos plus a USB charging function for smartphones and tablets as well as RGB backlighting that can be individually adjusted in color in the LEHMANN Management Software LMS. Emergency equipment, vital medicines and similar items must not be locked with these locks, as access to these items cannot be guaranteed in the event of a malfunction.

This operating instruction provides you with information on how to operate the locking system correctly. Keep the operating instructions in an easily accessible place. Incorrect use can destroy the locking system and lead to the loss of any warranty claims.

Please be sure to observe all warning and safety instructions and read the operating instructions completely before you start with the installation, commissioning and programming. The use of these locking systems in combination with additional mechanical or electronic solutions from other manufacturers must be checked for compatibility. We do not accept any liability for damage resulting from incompatibility.

Text and graphics have been prepared for you with care. No liability is accepted for any errors that occur.

Changes to the scope of delivery and the technical data are also possible without prior notice.

ATTENTION: The locking system can be configured with master and programming cards or with the LEHMANN Management Software LMS. The usage with master and programming cards is described in this document. The LMS software and the associated manuals can be found at <https://lms.lehmann-locks.com>.

SUPPLEMENTARY DOCUMENTS

- Operating instructions „Primary Controller / Secondary Controller“
- User manual for the LEHMANN Management Software LMS
- Installation manual for the LEHMANN Management Software LMS

TECHNICAL SPECIFICATIONS

Technical data Captos MIFARE or Captos iCharge MIFARE

RFID technology	MIFARE® Classic, MIFARE® DESFire® EV1 / EV2
Frequency	13,56 MHz National legislation about permissible radio frequencies must be observed.
Supported transponders	Compatible with the following RFID transponders: • MIFARE® Classic, • MIFARE® DESFire® EV1 / EV2, • ISO 14443A Existing transponders must be checked for compatibility and reading distance. „Shared Use“ mode is generally not supported for MIFARE Classic transponders. MIFARE Classic transponders are only processed to a limited extent in the LMS via the UID. To use the LEHMANN Transponder App via NFC technology on smartphones, please note the requirements: - Master card or LMS release 2.3 or higher - Lock firmware 2.3 or higher - Locks delivered after September 2025 - iPhone XS with iOS 17.4 or higher, and iPhones only within the European Economic Area - Reading distance depends on the smartphone and the installation situation and must be checked in advance.

Nominal Voltage	12 VDC
Power supply	via custom 4-wire cable from controller
Charging Current (iCharge)	max. 0,5 A
Operating temperature	-5 °C to +60 °C
Storage temperature	-25 °C to +70 °C
Status Indicator	2 LEDs on the front of the lock RGB for backlighting (only with CAPTOS iCharge)
Interface to Controller	RS485 via custom 4-wire cable
Connector	RJ12
Max. cable length	The max. cable length between lock and controller is 5m (1x 5m cable or 2x 2.5m cable with a coupling).
Reading distance	Up to 30mm with LEHMANN user cards (MIFARE® DESFire® EV1). Other transponders may have a shorter reading distance and must be checked in advance. The material of the furniture can influence the reading distance. A test on the furniture regarding the reading distance is therefore recommended.
Max. number of locks per controller	24
Distance	The distance between the locks must be at least 5 cm to avoid interference.
Minimum door width	The minimum distance between the door hinge and the middle of the locking pin must be at least 22.5 cm.
Material	Housing made of ABS, locking mechanism made of zinc die cast ZP5
Dimensions	75 x 75 x 26 mm
Weight	ca. 80 g
Compliance	CE, RoHS



SAFETY PRECAUTIONS

- Touching parts can lead to injuries from electric shock.
- Do not remove protective devices and covers.
- Do not touch the terminals when the product is receiving power.
- The installation, commissioning and maintenance of the locks and other components must be carried out by appropriately qualified personnel. In particular, electrical connections may only be carried out by qualified personnel. The installation regulations according to the relevant national regulations must be observed.
- Unless otherwise specified, the installation and maintenance of the devices must only be carried out in a voltage-free state. This applies in particular to devices that are connected to the low-voltage network.
- The housing of the locks must not be opened.
- Only LEHMANN Captos system components may be used.
- Damaged components must not be used.
- Electrical components must be checked regularly by qualified personnel in accordance with local regulations
- In the event of unusual heat or smoke development, the power plug must be pulled out immediately if this can be done without risk.

CARE & MAINTENANCE

- Do not spill any liquid over or into the individual components of the lock.
- Only clean the components of the locking system with a clean, soft and slightly damp cloth.
- Do not use any cleaning agents containing abrasives or solvents, as these may damage the housing. Glass cleaner, thinner, alcohol, gasoline or liquids containing ammonia are not suitable for cleaning.
- Improper handling of all electronic and mechanical components that deviate from the description in this user manual can lead to malfunctions.
- Check components for damage and replace damaged parts immediately.

FACTORY SETTINGS

At this point in time, the locking system can be closed and opened with one or more installation cards. To do this, the lock must be connected to a controller for power supply. The installation card can no longer be used after a master card has been programmed or after the lock has been programmed in the LEHMANN Management Software LMS.

FUNCTIONAL DESCRIPTION

With the locking system you can lock and unlock your furniture. RFID technology based on 13.56 MHz is used as the „key“. There are two operating modes available:

Operating mode	Description
Assigned use	There is a fixed assignment between transponders (user cards) and the lock. Transponders are programmed or deactivated at the lock by using a master card or the LMS. The lock thus allows selective access authorizations to be granted so that only authorized users with an authorized transponder receive access. A transponder can be programmed at several locks in the mode „assigned use“ at the same time. Up to 250 different transponders can be programmed per lock.
Shared use	A user can use a lock of his choice with a transponder. If a lock is closed with a transponder, the transponder and lock are linked to one another. The transponder cannot be used on any other lock in „shared use“ mode and the lock does not accept any further transponders. This coupling is only deactivated when the user opens the lock again with his transponder. The transponder can now be used for another lock.

OVERVIEW OF TRANSPONDER CARDS

Card type	Description
Installation card (only for assembly and testing purpose)	The installation card can be used especially for assembly and testing purposes in order to perform basic functions on the lock (opening and closing). This card is for universal use. Prior programming of a master card is not necessary. After programming the lock with a master card or with the LEHMANN Management Software LMS, the lock is disabled for the installation card.
Master card	For commissioning, a master card must be programmed. The master card is required for starting and terminating programming operations. This also includes the programming of user cards in „assigned use“ mode. The master card also enables the so-called Facility Manager function and the emergency opening of the lock. One master card can be programmed per lock. You can use one master card for several locks.
User card	User cards are used to open and close the lock. In „assigned use“ mode, up to 250 user cards can be programmed on one lock. In „shared use“ mode, one user card can be used temporarily on one lock. It is possible to program one user card on several locks in „assigned use“ mode, and at the same time on one lock in „shared use“ mode.

Programming card set	For certain programming functions, programming cards are required in conjunction with the master card. The programming card set consists of 3 programming cards: <ul style="list-style-type: none"> • P1: Mode (change of mode) • P2: Sound (activating or deactivating acoustic signals) • P3: Reset (reset to factory settings)
Programming card „P4: Auto Locking“	The programming card P4: Auto Locking can only be used in the operating mode „assigned use“. The activation takes place together with the master card. After opening the lock with a transponder, the lock closes automatically after 5 seconds.
Programming card „P5: Status-LED“	In conjunction with the master card, the status LED on the CAPTOS or CAPTOS iCharge can be deactivated and activated with the programming card P5: Status LED.
Programming card „P6: Unlimited Shared Use“	The programming card „P6: Unlimited Shared Use“ can be used in the „shared use“ mode. After activation, an RFID transponder can lock several locks at the same time (caution: even up to all locks!), instead of just one lock per transponder in this operating mode.
Update card	In conjunction with the master card, the update card allows firmware updates to be loaded into this system.
Service key	The individual service key allows a reordering of the master card. It is not possible to reorder a master card without a service key! This card has no electronic function!

You can either use user cards from LEHMANN or a third-party provider based on ISO 14443A as transponders / user cards. Please note the possible restrictions on user cards from third-party providers:

- The extensive security concept, which was specially designed for this locking system in connection with the user cards from LEHMANN Vertriebsgesellschaft mbH & Co. KG, may be affected when using user cards from a third party.
- The operating mode „shared use“ is only possible with user cards from third-party providers with the appropriate write access to the user cards.
- Transponder cards with a so-called „Random UID“ are not supported.

Third-party transponders must be checked in advance for compatibility and reading range.

To enable the highest possible level of security, transponder cards based on MIFARE® DESFire are required. MIFARE® Classic transponders are of limited use.

Please note that installation, master, user and programming cards must be ordered separately.

Store the master card and the card with the service key carefully and securely!

ADDITIONAL FUNCTIONS WITH THE CAPTOS iCHARGE

The Captos iCharge has compared to the Captos additionally a USB port for charging smartphones and tablets. Mobile devices are charged with up to 5 mA.

To do this, the device to be charged is connected to the USB port on the lock. Furthermore, in the LEHMANN Management software LMS a backlighting function can be activated and can be set individually.



POWER SUPPLY

The lock is powered by a controller. To do this, the lock must be connected to a controller by using a connecting cable. Further information on the controllers and on commissioning the controllers can be found in the operating instructions „Primary Controller / Secondary Controller“. If the power supply fails, the locks cannot be operated. You can find detailed information on the subject of emergency power supply in the operating instructions „Primary Controller / Secondary Controller“.

COMPONENTS OF THE LOCKING SYSTEM & PACKAGE CONTENT

Please note that this operating instruction applies to different product variants. The contents of the packaging therefore depend on the respective product variant. The product variants and installation recommendations shown here are intended for furniture with a wood thickness of 16-19 mm. If the materials are different, the screws for fastening the lock must be adapted. The operating instructions are part of the scope of delivery.

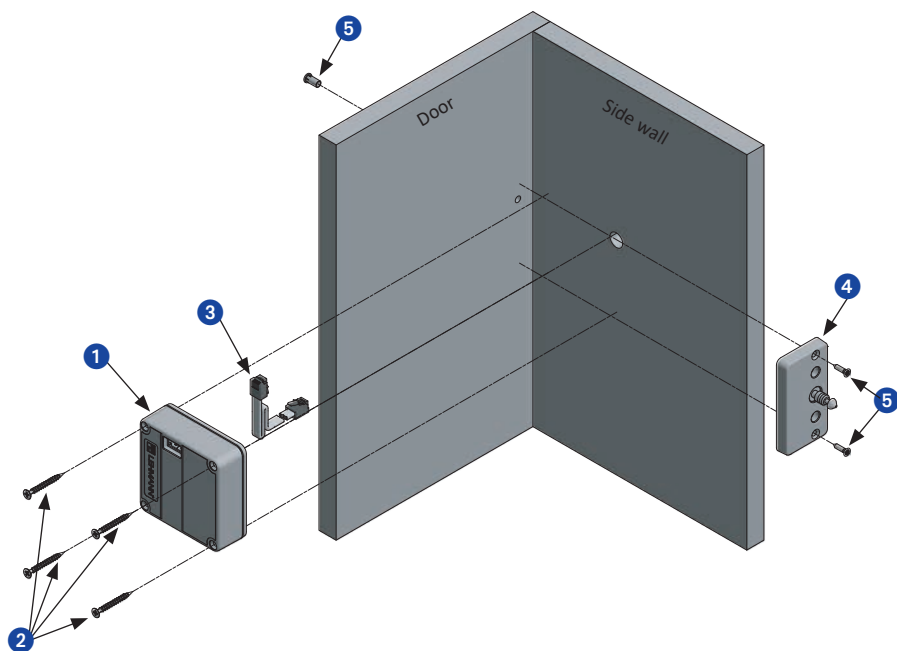

Components:

1. Lock Captos or Captos iCharge
2. 4 x countersunk screws 3.5 x 35 cross recess
3. Connecting cable (lock – controller)
4. Locking pin Type C
5. 2 x countersunk screws 3.5 x 20 cross recess for locking pin type C
6. Lightpoint (only optional)

Ejector pin A2 (optional)

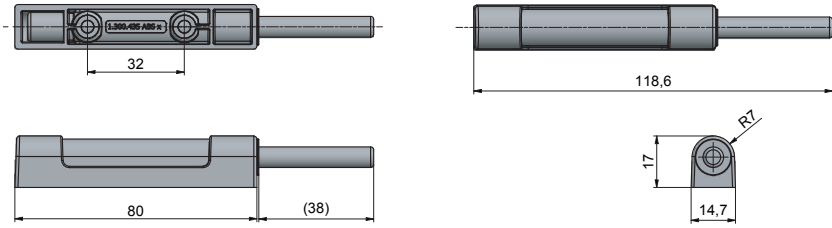

Lightpoint (optional)

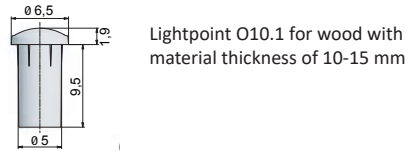
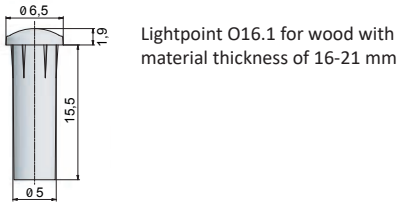

Connecting cable lock - controller

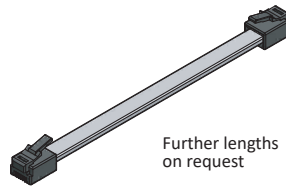
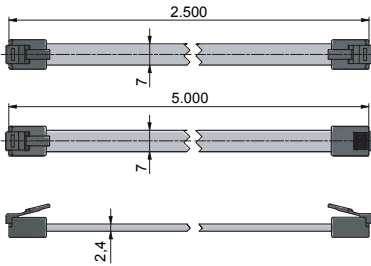

GENERAL ASSEMBLY INSTRUCTIONS

IMPORTANT: Only install the locking system when it is unlocked. Hand-tighten all screws. The use of the ejector pin in connection with spring-loaded hinges must be checked on a project-specific basis.

Maximum door thickness for non-metallic doors: 19 mm

The maximum door thickness for non-metallic doors depends, among other things, on the reading range between the lock and the transponder. The reading range can vary depending on the transponder. A compatibility and reading distance test is necessary when using existing third-party transponders.

Installation for locker walls with doors hinged on the right and left

The lock has two LEDs aligned symmetrically on the front of the lock. Only one lightpoint per lock is recommended in the door. Due to the symmetrical arrangement of the lock, locks and lightpoints can always be installed at the same height on a locker wall regardless of left- and right-handed doors.

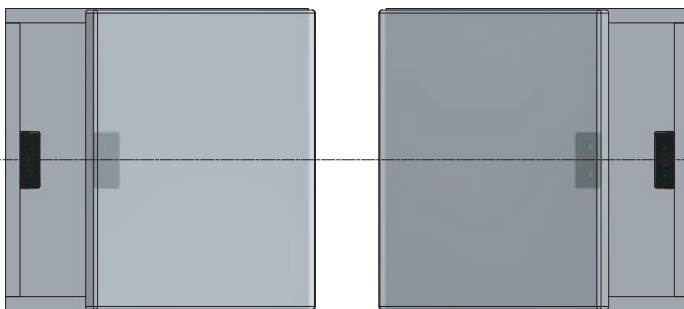

The distance between Captos or Captos iCharge locks must be at least 5 cm.

MOUNTING ON NON-METAL SURFACES

The lock is mounted on the right or left wall inside of the locker, depending on the door hinge. The locking pin is mounted on the inside of the door.

The following describes the individual steps for installing the lock on the inside of the cabinet for a locker with a right-handed door.

- Pre-drill the four mounting holes for the lock as shown in the drawing (see figure: Mounting position on non-metallic surfaces). No through hole!
- Insert the plug of the connecting cable that connects the lock and controller into the socket on the lock until it clicks. Place the connecting cable in loops that are large enough in the lock housing to enable later assembly / disassembly (see figure: inserting the connecting cable into the lock). The cable must be routed out of the locker so that it can be plugged into the controller later on (see operating instructions “Primary Controller / Secondary Controller”). If the cable is laid in the inside of the locker, the plastic edge for the cable breakthrough must be broken out on the back of the lock.
- Please note on page 12 the recommendations and options for laying cables between the lock and controller and the additional drilling that may be necessary. In the following drawings, a hole in the body side wall is shown as an example.

- Screw the lock onto the wall unit. Hand-tighten all screws. The lock must lie flat on the wall unit. The connection cable must not be squeezed.
- Pre-drill the two mounting holes for the locking pin on the inside of the door as shown in the drawing (see figure: mounting position on non-metallic surfaces). No through hole!
- If an optional lightpoint is to be installed, drill a through hole (see figure: Mounting the lightpoint).
- Screw the locking pin onto the inside of the door. Hand-tighten the screws

Figure: Mounting position on non-metallic surfaces

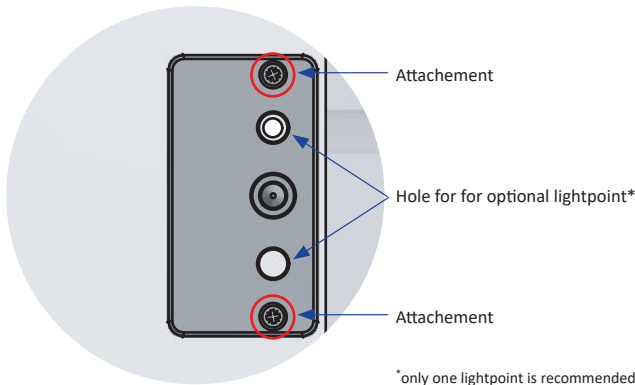
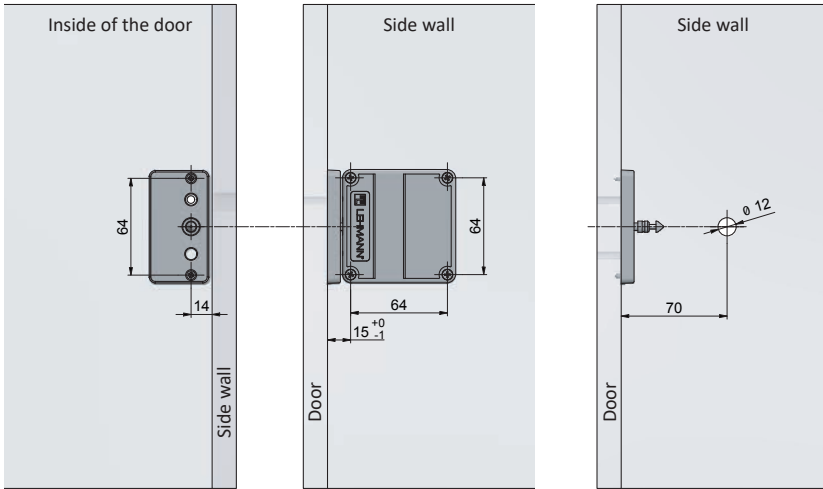
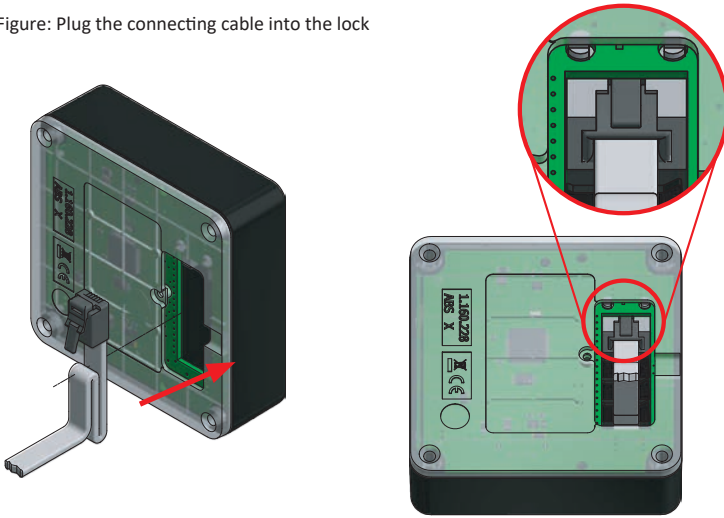

Figure: Plug the connecting cable into the lock



1. Insert the connector of the connecting cable into the socket in the lock.
2. For later assembly or disassembly purposes, stow the connection cable approx. 10-15cm in loops in the lock. Lead the cable out of the lock (e.g. through the side wall) and assemble the lock on the inside wall of the body.

Installation instructions for the ejector pin A2 on non-metal surfaces

An ejector pin can optionally be mounted on the inside of the sidewall of the locker. When the lock is unlocked, the ejector pin pushes the locker door open by approx. 2 cm. The use of the ejector pin A2 in connection with spring-loaded hinges must be checked on a project-specific basis.

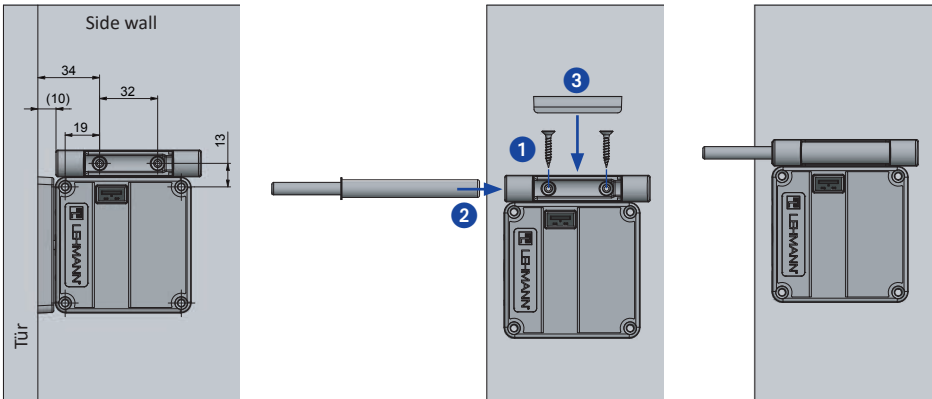

1. Fasten the housing of the ejector A2 with the provided screws.
2. Insert the ejector pin into the housing.
3. Press the cover onto the ejector pin.

Installation instructions for the optional lightpoint O10.1 or O16.1

Note that the lightpoint can be mounted optionally. Without a lightpoint, only acoustic signals are available. The lock has two LEDs aligned symmetrically on the front of the lock. Only one lightpoint in the door is recommended for each lock.

Figure: Mounting the lightpoint

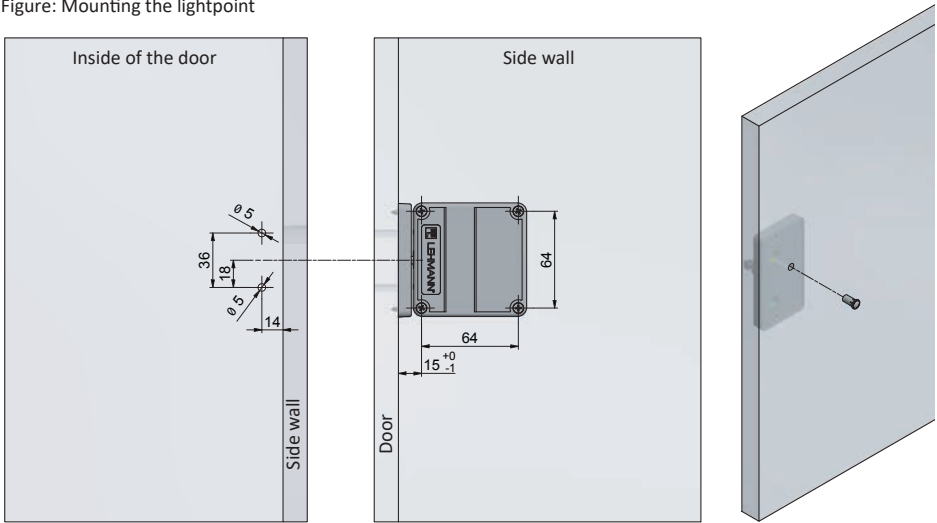

A lightpoint is recommended. Therefore, drill only one hole for the lightpoint. The lightpoint can be assembled without tools.

CABLE MANAGEMENT RECOMMENDATIONS

There are different ways to route the cable from the lock on the inside of the body to the controller. Three examples of possible cable routing are given below. Further cable management recommendations are given in the operating instructions „Primary Controller / Secondary Controller“.

a) Cable routing on the outside of the body made of wood or HPL with grooves

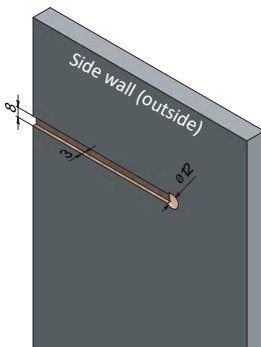

Side wall of locker with groove 8x3mm and hole 12mm.

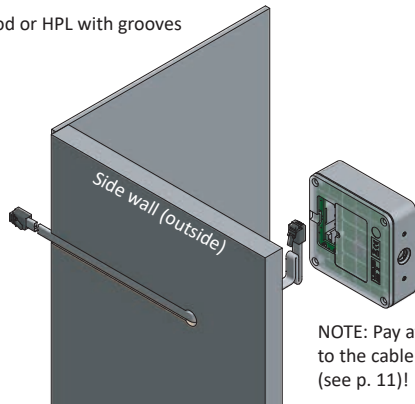

Guide the cable through the hole and connect it with a lock on the one side. Lay it in the groove on the other side and lead it to the controller.

All information in mm

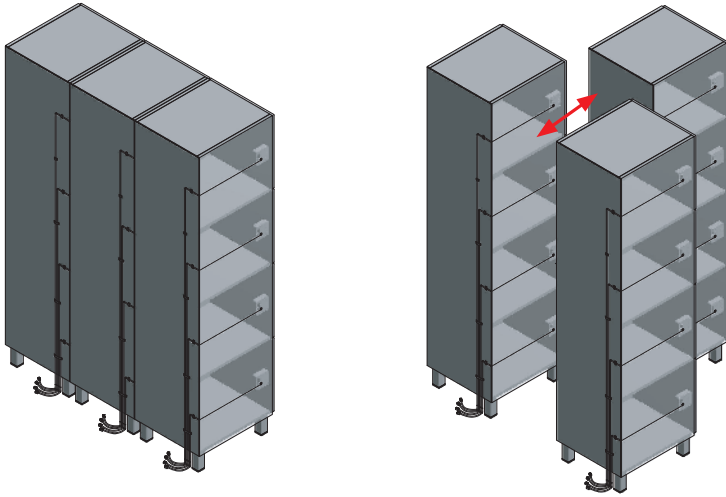

b) Cable routing on the inside of the body made of wood or HPL with grooves

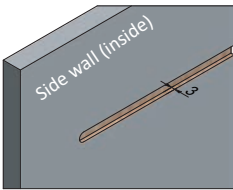

Side wall (inside) with groove 8x3mm.

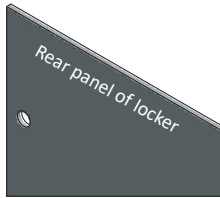

Rear panel of locker with 12mm hole.

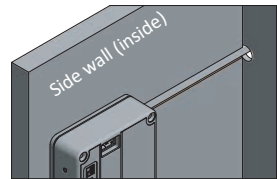

Connect the cable to the lock, lay it in the groove and feed it through the hole on the back. If the cable is laid inside the cabinet, the plastic edge for the cable breakthrough must be broken out on the back of the lock.

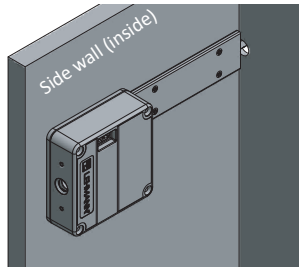
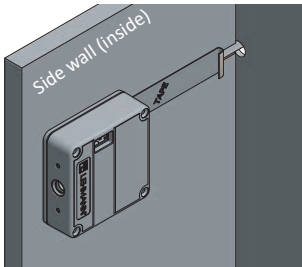

Secure / cover cable with tape or cover strip.

c) Cable routing on the inside of the body made of wood or HPL without grooves

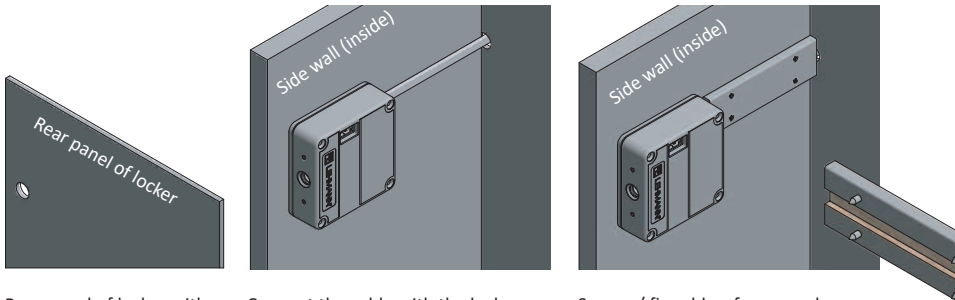

Rear panel of locker with 12mm hole

Connect the cable with the lock. Break out the plastic edge for the cable breakthrough on the back of the lock. Lay the cable to the rear and feed it through the hole on the rear.

Secure / fix cables, for example with a profiled cover strip.

CONFIGURATION AND OPERATION

The locking system can be configured with master and programming cards or with the LEHMANN management software LMS. For full use of the locking system, networking via the customer's LAN with the LMS is recommended.

Further information on commissioning the controller can be found in the operating instructions „Primary Controller / Secondary Controller“. A detailed description of the LMS software can be found in the separate LMS manual. The LMS software and the associated manuals can be found at <https://lms.lehmann-locks.com>.

The following explains the configuration and operation of the locks when using master and programming cards. If the configuration is carried out with master and programming cards, the controllers are used only for power supply. The controllers do not have to be networked with one another in this constellation. Information on the power supply via the controller can also be found in the operating instructions „Primary Controller / Secondary Controller“.

INSTRUCTIONS FOR OPERATION AND CONFIGURATION

To read a transponder, the locking pin on the inside of the door must be in the lock. To do this, close the door. When using an ejector pin, press the door into the lock with one hand while programming.

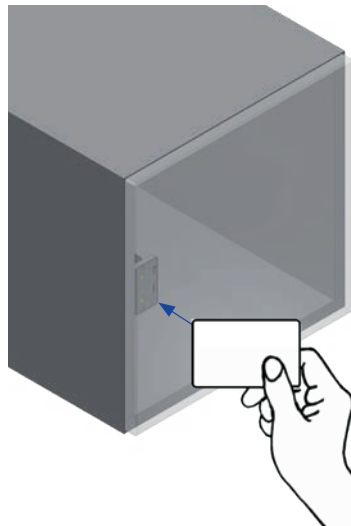

Make sure to position the transponder in the middle in front of the locking pin / in front of the lock.

The last 5 seconds before the programming process is switched off are indicated by yellow flashing and acoustic signals. Optical signals are only visible after the optional light guide has been installed.





The optical and acoustic signals are differentiated as follows:

Optical signals

-  Quick flashing
-  Short flashing
-  Long flashing

Acoustic signals

-  Short
-  Long

COMMISSIONING

Power supply is established

Power supply is established



USING THE INSTALLATION CARD

During installation, one or more installation cards can be used. The installation cards are ready for immediate use and do not have to be programmed. With the installation cards, the basic functions (opening and closing) can be carried out on the lock. It is not possible to program user cards with the installation card. The installation card can no longer be used on a lock as soon as the master card has been programmed.

Closing



Hold the installation card in front of the lock.



Opening



Hold the installation card in front of the lock.



PROGRAMMING THE MASTER CARD

Irrespective of the desired operating mode, a master card must always be programmed before further programming and operation. Only one master card can be programmed per lock! The programming of the master card can be carried out when the lock is closed as well as when it is open. If the lock is closed after the master card has been programmed, the next step must be an emergency opening (see Emergency opening, P. 18).

Programming the master card for the first time









Hold the master card in front of the lock.

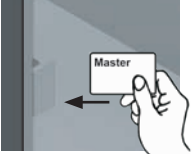

The locking system is in „assigned use“ mode after the master card has been programmed. If you would like to use the lock in “shared use“ mode, the next thing to do is to change the operating mode. To do this, please follow the instructions on page 20 and then continue with the section “Closing and Opening“ on page 17.

PROGRAMMING THE USER CARDS (only for “assigned use“ mode)

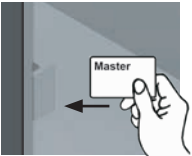
In “assigned use“ mode, a maximum of 250 different user cards can be programmed per lock. It is not possible to program user cards in “shared use“ mode. In “shared use“ mode, the lock can be opened and closed without programming the user cards (see Closing and Opening). For the programming of transponders, the lock must be in open position.

Programming user cards	
 <p>Hold the master card in front of the lock.</p>	
 <p>Hold the user card in front of the lock. The card is accepted and programmed. This process can be repeated to program multiple user cards.</p> <p>Card is not accepted.</p>	
 <p>Hold the master card in front of the lock.</p>	

After programming, the user cards can open and close the lock.

CLOSING AND OPENING

<p>Closing</p>  <p>Hold the user card in front of the lock.</p>	
---	---

Opening



Hold the user card
in front of the lock.



UNAUTHORISED TRANSPONDERS

Rejection of an unauthorised user card



Unauthorised user card is
held in front of the lock.
The card is rejected.



FACILITY MANAGER FUNCTION

In the event that an authorised person only briefly wants to check whether for example a locker is occupied, the lock can be opened with the master card. With this function, the lock opens for 30 seconds and then closes automatically. After this automatic closure, authorised user cards can continue to be used in “shared use” mode as well as in “assigned use” mode. The last 5 seconds before closing are indicated by optical and acoustic signals.

Facility Manager Function

(lock closes automatically after 30 seconds)







Hold the master card
in front of the lock.



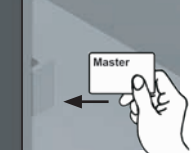





EMERGENCY OPENING

In the event that one or all authorised user cards are currently not available, an emergency opening can be effected with the master card. Please note that the lock remains open after emergency opening. In the “Shared use” mode, the previously used user card is blocked after emergency opening, and can no longer be used. In “Assigned use” mode, user cards can continue to be used normally.

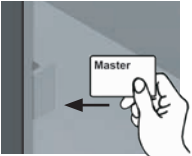
Emergency Opening	
 <p>Hold the master card in front of the lock.</p>	
 <p>Hold the master card in front of the lock.</p>	

DELETING INDIVIDUAL TRANSPONDER CARDS (only for “assigned use” mode)

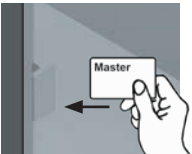



If further user cards were programmed on the lock, these can continue to be used on this lock after an individual user card has been deleted. For the deleting process, the lock must be open. To do this, first carry out an emergency opening with the master card if necessary (see Emergency opening, P. 18).

Deleting individual user cards	
 <p>Hold the master card in front of the lock.</p>	
 <p>Hold the user card to be deleted in front of the lock.</p>	
 <p>Hold the master card in front of the lock.</p>	

Should the user card be lost, then please proceed as follows.

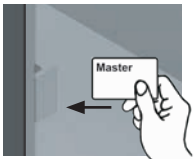
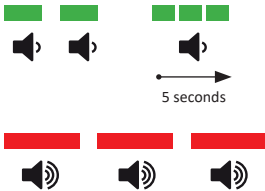



DELETING ALL TRANSPONDER CARDS (only for „assigned use“ mode)



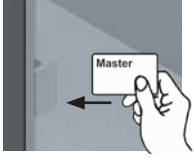

The deleting process can only be carried out when the lock is open. Should there be no authorised user card to hand, first perform an emergency opening using the master card.

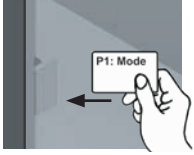
Deleting all user cards	
 <p>IMPORTANT: Hold the master card in front of the lock until all of the following optical and acoustic signals have been performed.</p>	
 <p>IMPORTANT: Hold the master card in front of the lock until all of the following optical and acoustic signals have been performed.</p>	
 <p>Hold the master card in front of the lock.</p>	

CHANGING THE OPERATING MODE

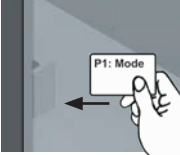





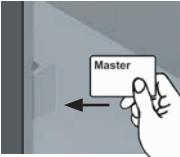

The lock has two modes: “assigned use” and “shared use”. When the lock is open, you have the option of changing the mode. To do this, the master card and the programming card No. 1 (P1: Mode) are required. The programming card set must be bought separately from LEHMANN Vertriebsgesellschaft mbH & Co. KG. The cards are for universal use.

Changing the operating mode	
 <p>Hold the master card in front of the lock.</p>	
 <p>Hold the programming card “P1: Mode” in front of the lock. “Shared use” mode is selected.</p>	<p>Shared use</p> 

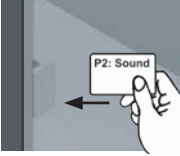
	<p>Hold the programming card "P1: Mode" in front of the lock again. "Assigned use" mode is selected.</p>	<p>Assigned use</p> 
	<p>Hold the master card in front of the lock.</p>	

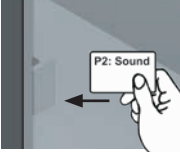

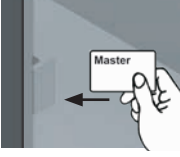



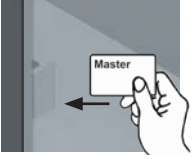

DEACTIVATING AND ACTIVATING ACOUSTIC SIGNALS

Acoustic signalling is activated when the system is delivered. You have the option of deactivating the acoustic signals with the aid of the master card and the programming card No. 2 (P2: Sound). For this, the lock must be open. It is recommended that the acoustic signals should only be deactivated if the RFID reader with the LED is mounted outside the item of furniture. Otherwise, neither visual nor acoustic signals are passed on to the users, making programming and possibly also operation difficult. Please note that the acoustic signals for the battery warning and for changing the operating mode cannot be deactivated. The programming card set must be bought separately from LEHMANN Vertriebsgesellschaft mbH & Co. KG. The cards are for universal use.

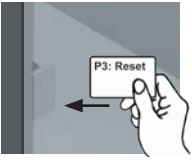
Deactivating and activating acoustic signals		
	<p>Hold the master card in front of the lock.</p>	
	<p>Hold the programming card "P2: Sound" in front of the lock. The acoustic signals are deactivated.</p>	<p>Acoustic signals are deactivated</p> 
	<p>Hold the programming card "P2: Sound" in front of the lock. The acoustic signals are activated.</p>	<p>Acoustic signals are activated</p> 
	<p>Hold the master card in front of the lock.</p>	

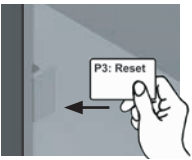
RESETTING TO FACTORY SETTINGS (RESET)

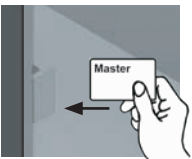
If a reset to factory settings is required, all master and user cards are deleted. With an installation card the basic functions (close and open) can be carried out. The bolt is retracted, and the lock must be reprogrammed with a master card. The reset function can be used with the help of the master card and programming card No. 3 (P3: Reset). For this, the lock must be open. The programming card set must be bought separately from LEHMANN Vertriebsgesellschaft mbH & Co. KG. The cards are for universal use.







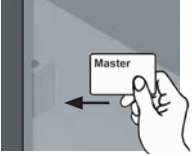

Resetting to factory settings	
 <p>Hold the master card in front of the lock.</p>	
 <p>Hold the programming card "P3: Reset" in front of the lock.</p>	
 <p>Hold the programming card "P3: Reset" in front of the lock again.</p>	
 <p>Hold the master card in front of the lock. During the initialisation, no transponders may be within reading range of the lock.</p>	

ACTIVATION AND DEACTIVATION OF AUTO LOCKING

With the programming card "P4: Auto Locking", the function „Automatic locking“ can be activated and deactivated in the operating mode „assigned use“. Once the function is activated, the lock closes automatically after 5 seconds after opening the lock with an authorized transponder.





The function can be carried out by using the master card and the programming card "P4: Auto Locking". To do this, the lock must be in the mode „assigned use“ and in an open position. If the operating mode changes, this function is automatically deactivated. The programming card must be purchased separately from LEHMANN Vertriebsgesellschaft mbH & Co. KG. The card can be used universally.



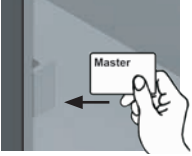

NOTE: If the „automatic locking“ function is activated, hold the master card in front of the lock immediately after opening the lock in order to start programming. Otherwise the lock will lock automatically after 5 seconds. Configuring the lock including programming transponders is only possible when the lock is open.

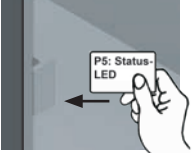
Activate or deactivate the feature automatic locking	
 <p>Hold the master card in front of the lock.</p>	
 <p>Hold the programming card "P4: Auto Locking" in front of the lock. The function "auto locking" is activated.</p>	<p>Auto locking is activated</p> 
 <p>Hold the programming card "P4: Auto Locking" in front of the lock. The function "auto locking" is deactivated.</p>	<p>Auto locking is deactivated</p> 
 <p>Hold the master card in front of the lock.</p>	

DEACTIVATING AND ACTIVATING THE STATUS-LED

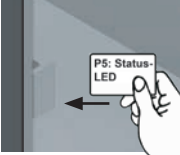
The status LED is activated when the system is delivered. You have the option of deactivating the status LED with the master card and the programming card P5: Status-LED. The lock must be in position open in order to make the changes.

Deactivating and activating Status-LED	
 <p>Hold the master card in front of the lock.</p>	
 <p>Hold the programming card „P5: Status-LED“ in front of the lock. The Status-LED is deactivated.</p>	<p>Status-LED is deactivated</p> 

	<p>Hold the programming card „P5: Status-LED“ again in front of the lock. The Status-LED is activated.</p>	<p>Status-LED is activated</p> 
	<p>Hold the master card in front of the lock.</p>	

ACTIVATION AND DEACTIVATION OF UNLIMITED SHARED USE

With the master card and the „P6: Unlimited Shared Use“ programming card, the function can be activated and deactivated in the „shared use“ mode. After activation, an RFID transponder can lock several locks at the same time (caution: even up to all locks!), instead of just one lock per transponder in this operating mode. To activate and deactivate the function, the lock must be in an open position. The configuration process is the same process as the activation and deactivation of the auto locking function (see page 17).

DISPOSAL

Dispose of the locking system in accordance with local regulations and guidelines.

LEHMANN Vertriebsgesellschaft mbH & Co. KG
 Uphauer Weg 82 • D-32429 Minden
 Fon +49 571/50 599-0 • Fax +49 571/50 599-822
 info@lehmann-locks.com • www.lehmann-locks.com
 DIN EN ISO 9001:2015 zertifiziert